

SC 150

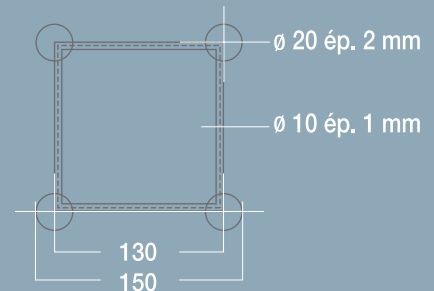

CHARGES MAXIMALES (1/100)*		
Portée (m)	Q	P1
	(kg/ml)	(Kg)
2	326	320
4	77	140
6	30	72
8	14	48

CHARGES PRÉCONISÉES (1/300)**		
Portée (m)	Q	P1
	(kg/ml)	(Kg)
2	326	320
4	58	135
6	13	33
8	2	-

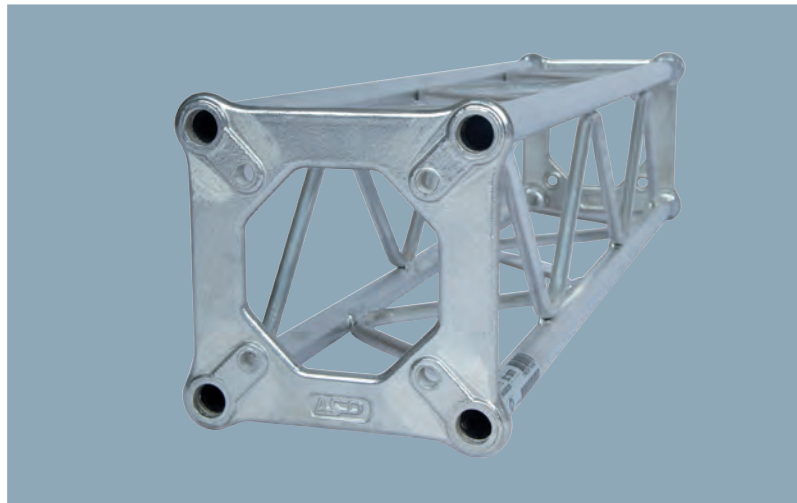

Sous réserve que l'utilisateur ait vérifié au préalable la stabilité au non-basculement de la poutre

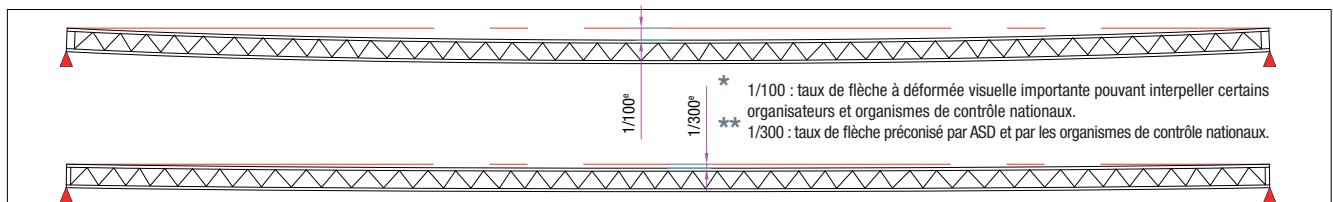

Poutres

Livrées avec kit

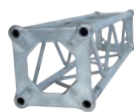

LONGUEUR (m)	0,25	0,35	0,50	0,70	1,00	1,50	2,00	2,50	3,00
POIDS (KG)	0,7	0,8	0,95	1,1	1,5	2,15	2,8	3,45	4
RÉFÉRENCE	SC15025	SC15035	SC15050	SC15070	SC15100	SC15150	SC15200	SC15250	SC15300

Cercles

Livrés avec kits



Ø EXTÉRIEUR (m)	2,00	2,50	3,00	4,00	5,00	6,00	7,00	8,00
NBRE ÉLÉMENTS	2	2	4	4	6	6	8	8
RÉFÉRENCE	SCC15200	SCC15250	SCC15300	SCC15400	SCC15500	SCC15600	SCC15700	SCC15800

SC 150

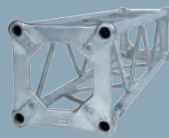

Angles

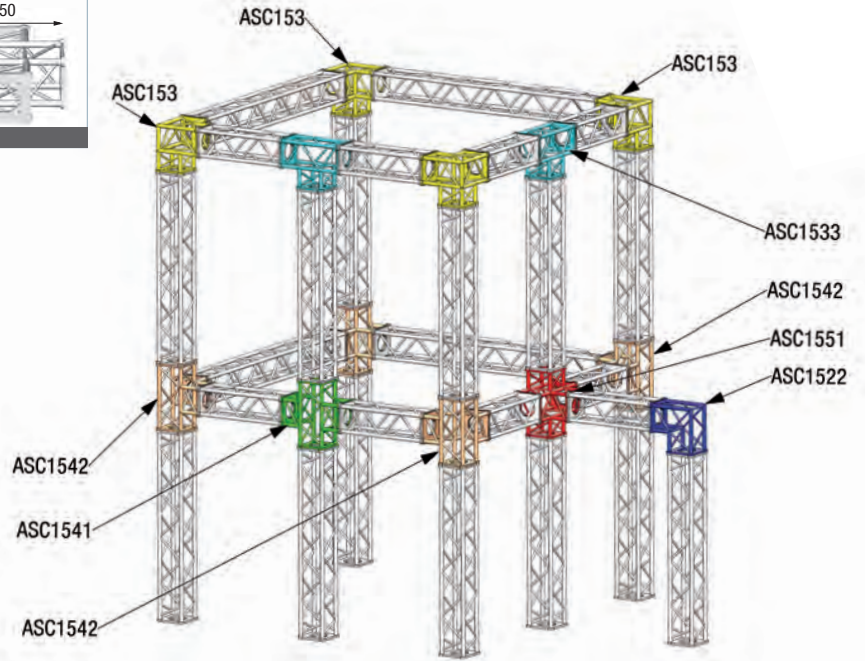
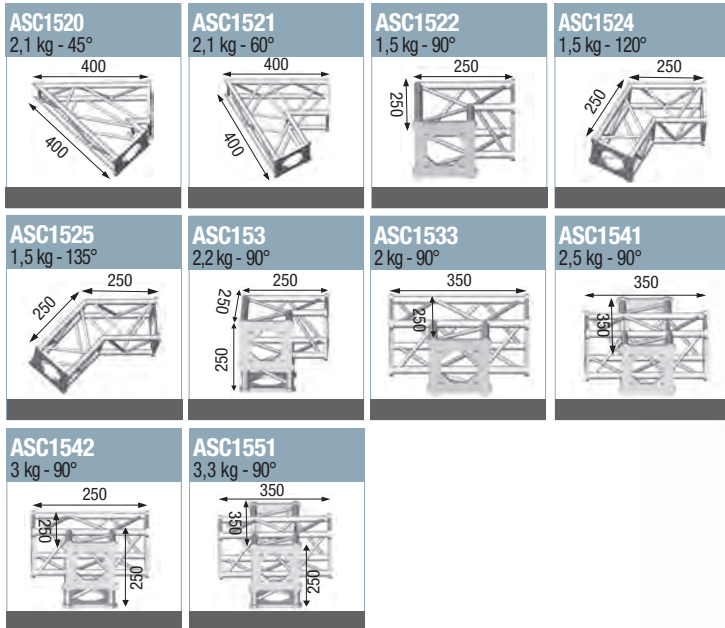

Accessoires optionnels

EMBASES DE SOL ALU LÉGÈRES

EM159A

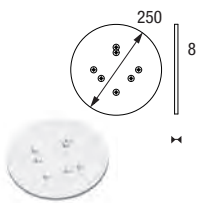

livrée sans kit

Poids : 2 kg

EMBASES DE SOL ACIER LOURDES

EML40

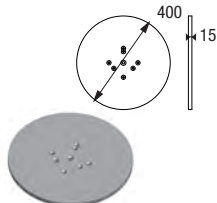

livrée sans kit

Poids : 15 kg

JONCTIONS

MD150A

Kit de jonction structure



4 vis, 4 écrous freins
4 écrous papillons M10

Poids : 0,1 kg

MDE150A

Kit de jonction pour embase

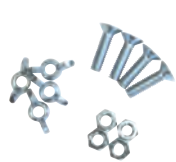

4 vis à tête fraisée pour embase lourde
4 écrous freins, 4 écrous papillons M10

Poids : 0,1 kg

ACCESSOIRES

SP125C Suspension
pour élingue ou chaîne

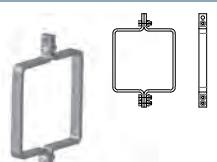

Afin de suspendre les poutres SC 150 pointe en haut ou pointe en bas
Charge : 90 kg
Poids : 8 kg

FM20

Fixation murale

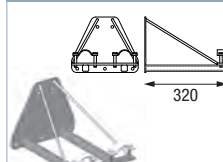

Pointe en haut uniquement
Charge : 230 kg
Poids : 4 kg

PEINTSC150

Peinture époxy



le ml
RAL au choix.....